



**Features:**

- Universal AC input/ Full Range
- Energy Efficiency Level V
- ErP Step 2 Compliant
- ANSI/AAMI/IEC/EN ES60601-1:2005 (60601 3rd Edition)
- Output Protections: OVP/SCP/OCP
- No Load Power Consumption <0.5W
- 2 Year Warranty



Model	QAMA-90-12	QAMA-90-15	QAMA-90-19	QAMA-90-24	QAMA-90-36	QAMA-90-48
<b>Output Characteristics</b>						
DC Output	12V	15V	19V	24V	36V	48V
Rated Current	7.5A	6.00A	4.74A	3.75A	2.50A	1.88A
Ripple and Noise	±2% Vo @ Rated Load					
Load Regulation (Typ.)	±5%					
Transient Response (Typ.)	0.5mS for 50% Load Change					
Hold-up Time (Typ.)	10mS @ Rated Load					
Output Protection	Short Circuit, Over Voltage, Over Current					
Ferrite Core	Yes					
<b>Input Characteristics</b>						
Voltage Range	100VAC~240VAC					
Frequency Range	50Hz-60Hz					
Efficiency	Energy Star Level V, ErP Step 2					
AC Current (max)	1.2A					
Input Protection	Internal Primary Current Fuse, Inrush Limiting					
Leakage Current	0.5mA					
<b>Environmental Characteristics</b>						
Operating Temperature	0°C~40°C					
Operating Relative Humidity	20% RH to 80% RH					
Storage Temperature	-20°C~80°C, 10% RH to 90% RH					
Topology	Switching Flyback					
Dielectric Withstand	4000VAC Primary-Secondary					
EMI Conduction & Radiation	Compliance to EN55011 Class B					
Harmonic Current	Compliance to EN61000-3-2,3					
EMS Immunity	IEC60601-1-2					
<b>Characteristics</b>						
MTBF	300,000Hrs (25°C, Telecordia SR-332)					
Dimension (LxWxH)	168x66x39mm					
Weight	600g					

**PART NUMBER SYSTEM**

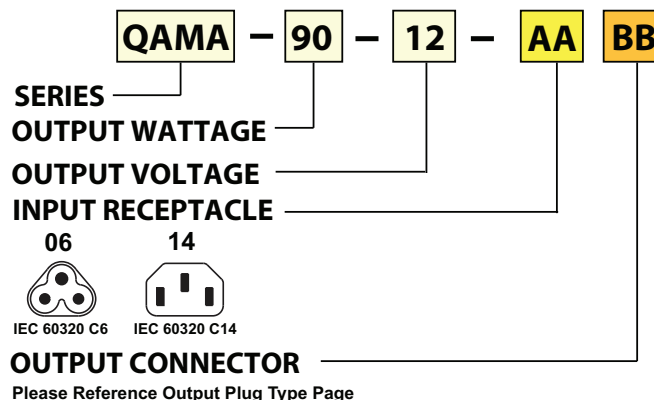

## MECHANICAL SPECIFICATIONS

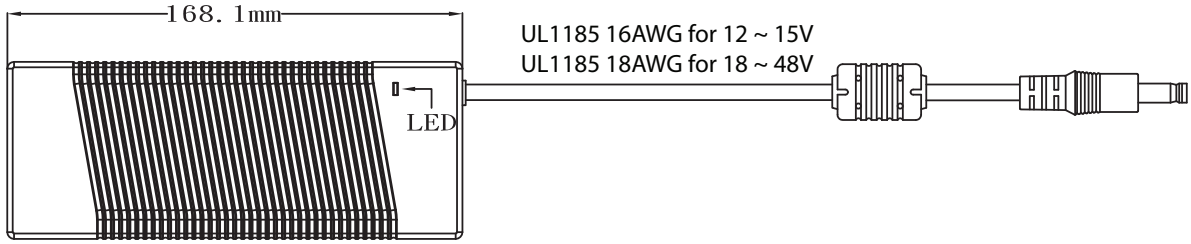

TOP-VIEW

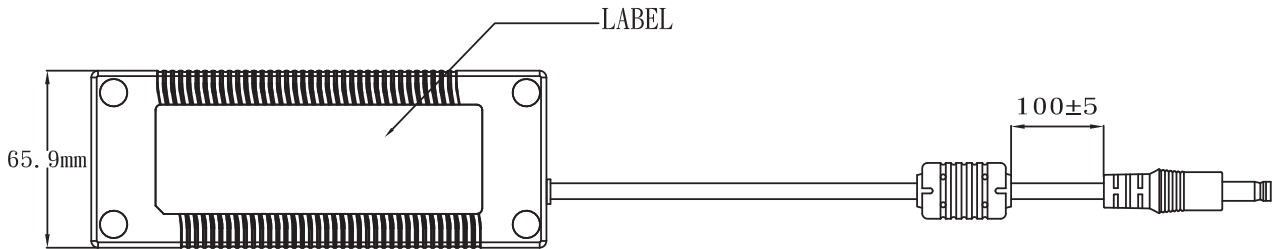

BOTTOM-VIEW

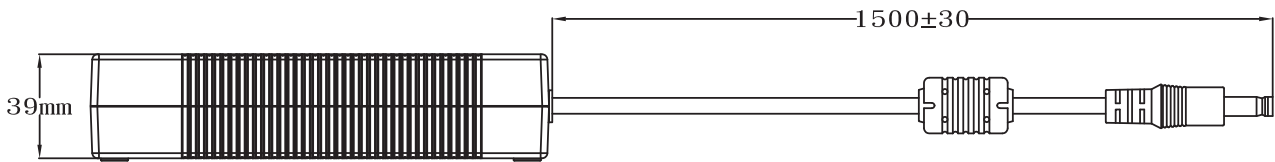

SIDE-VIEW

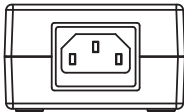

FRONT-VIEW

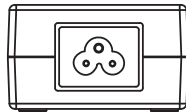

## DERATING CURVE

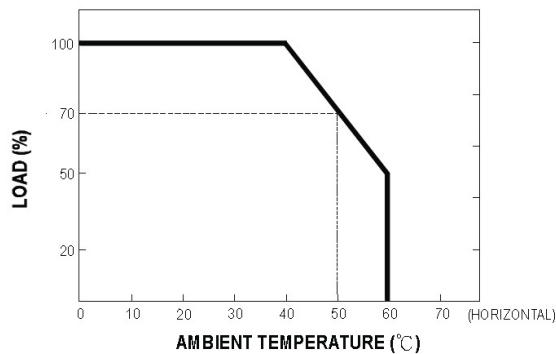

UNIT: mm